

40690/**/16



Gebruiksaanwijzing
Notice d'emploi
Benutzerhandbuch
User manual
Manual de usuario
Manual do usuário



PHILIPS

Incl.



8x Luxeon Rebel
Powered

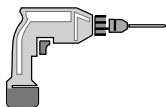
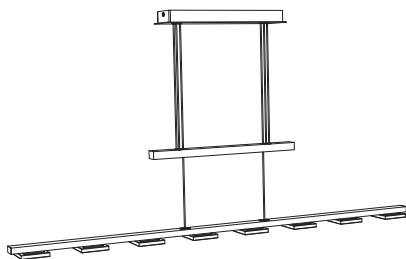

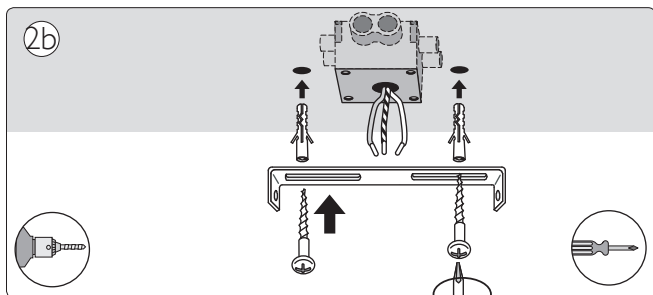
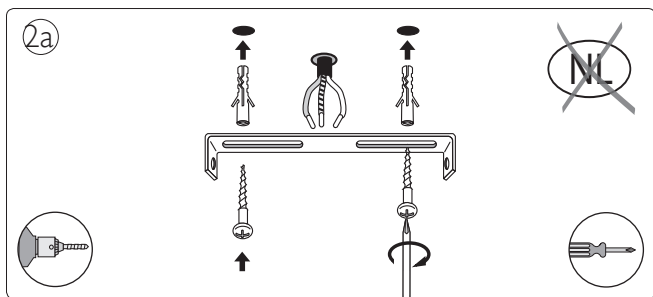
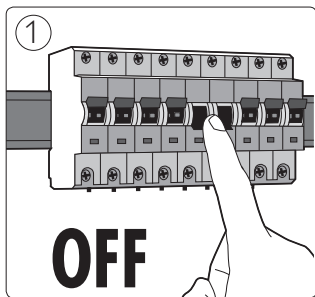

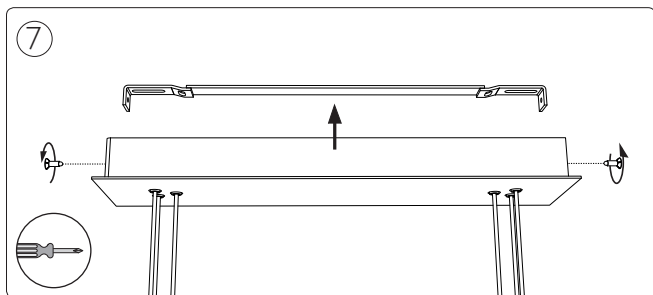
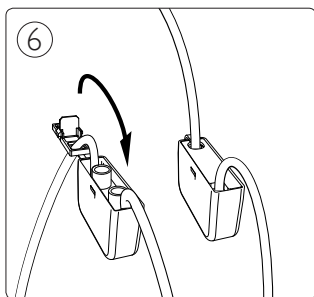
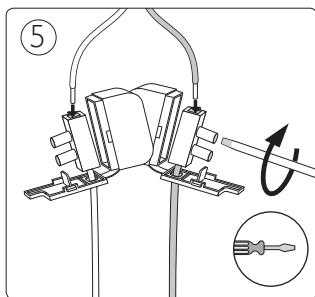
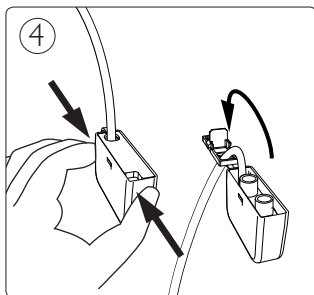
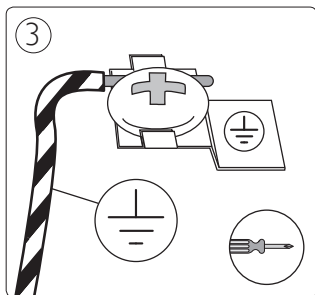

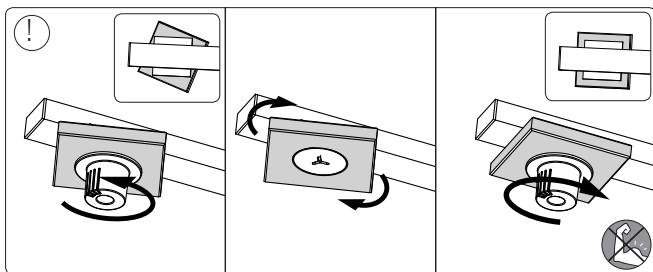
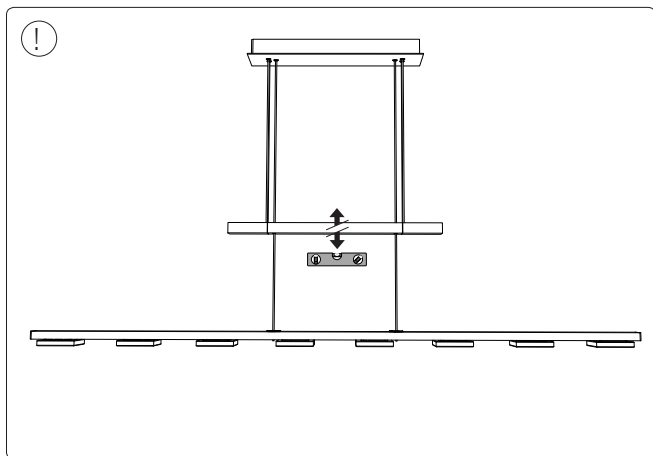



Philips Lighting Contact Centre
Int. Business Reply Service
I.B.R.S. / C.C.R.I. Numéro 10461
5600 VB Eindhoven
Pays-Bas / The Netherlands

www.philips.com/homelighting
 +800 7445 4775

4404.018.35521
Last update: 10/04/13