

30422/\*\*/16



Gebruiksaanwijzing

Notice d'emploi

Benutzerhandbuch

User manual

Manual de usuario



# PHILIPS

Incl.

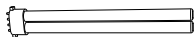
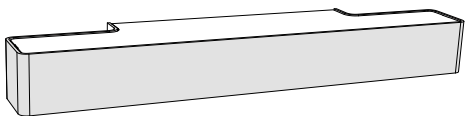

Excl.

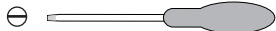
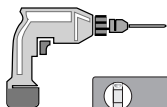

Type I → p.4

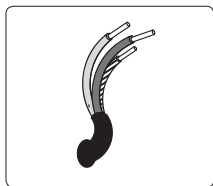
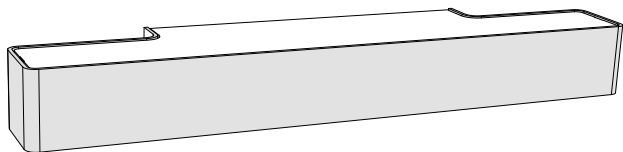

Type II → p.8

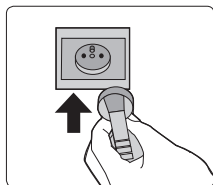
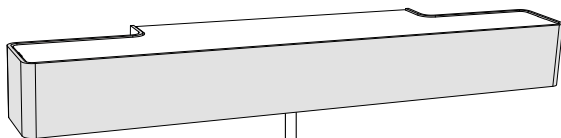

Type I

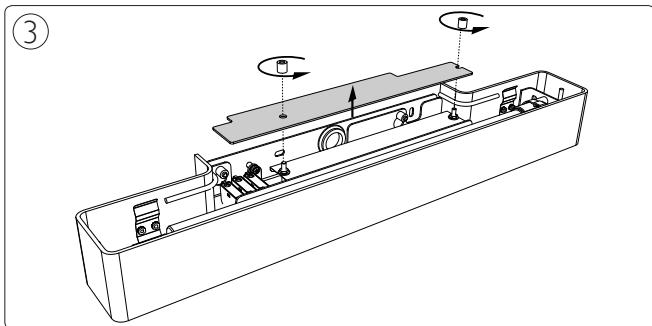
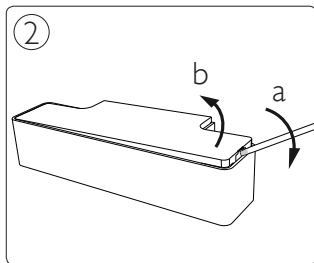
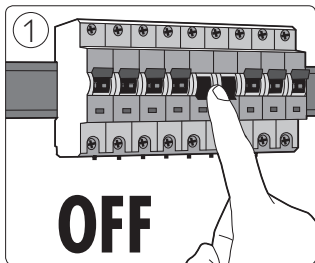

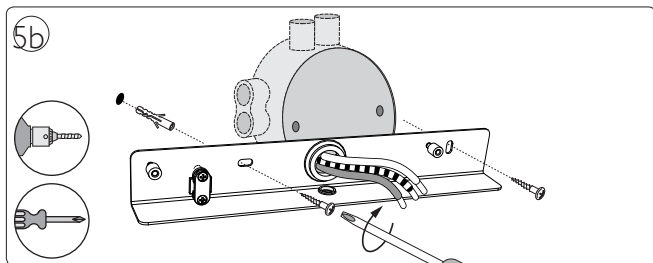
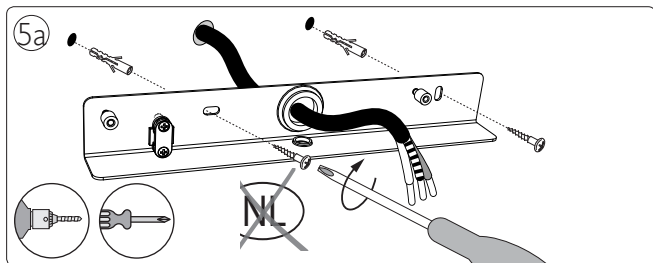
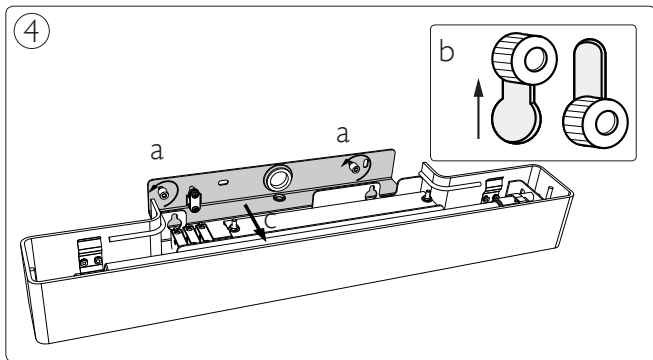

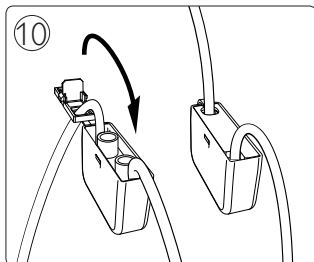
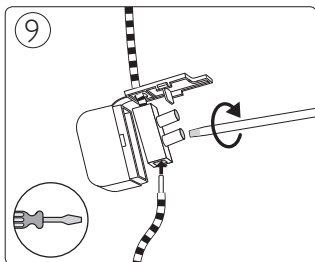
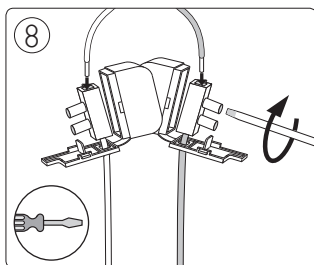
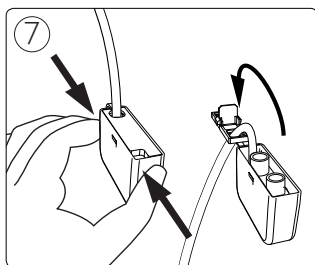
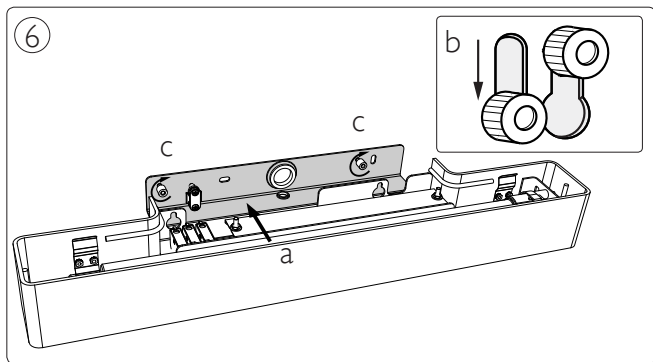

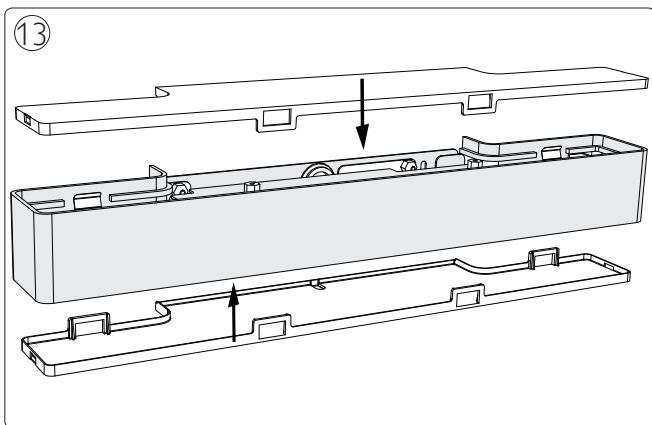
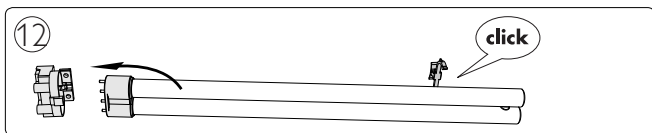
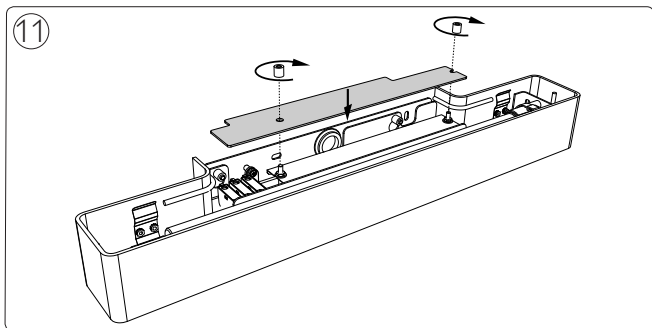

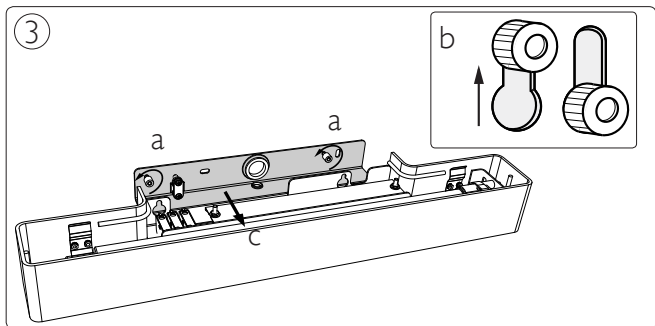
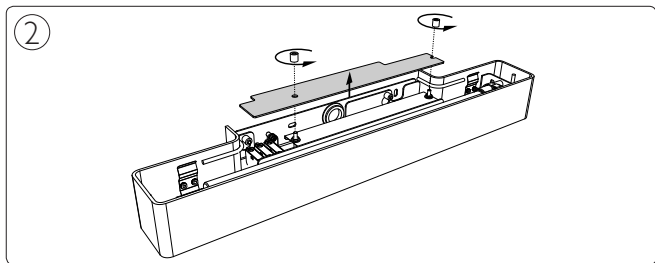
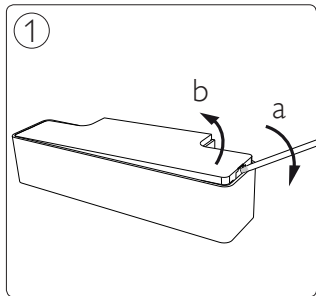
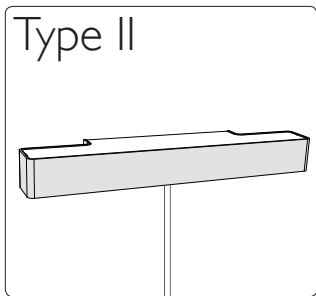



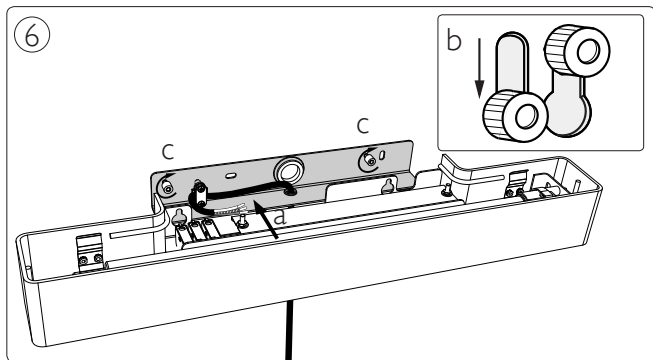
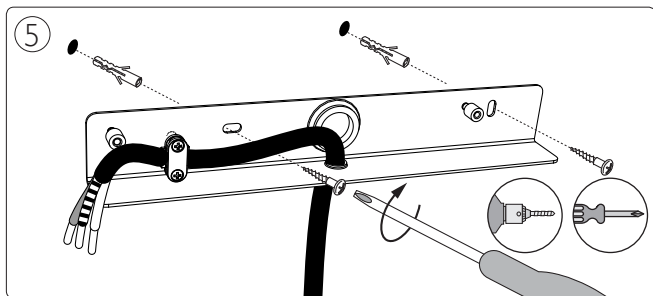
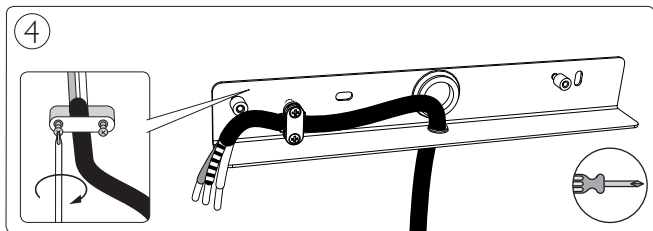

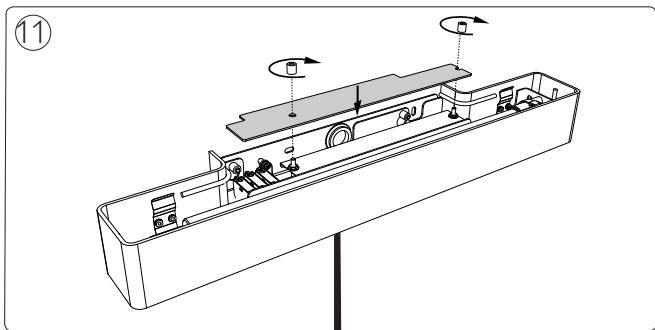
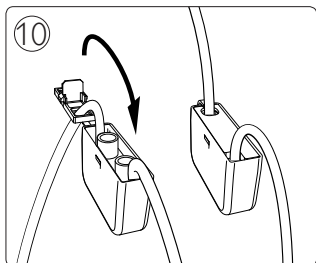
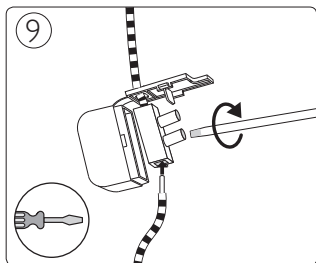
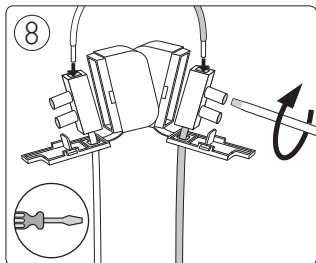
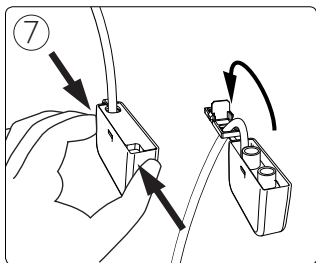

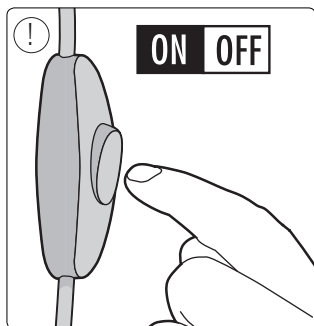
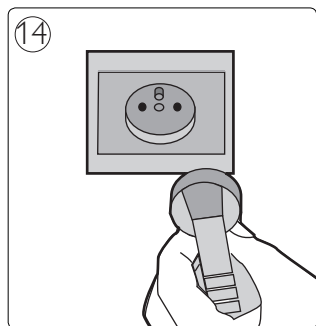
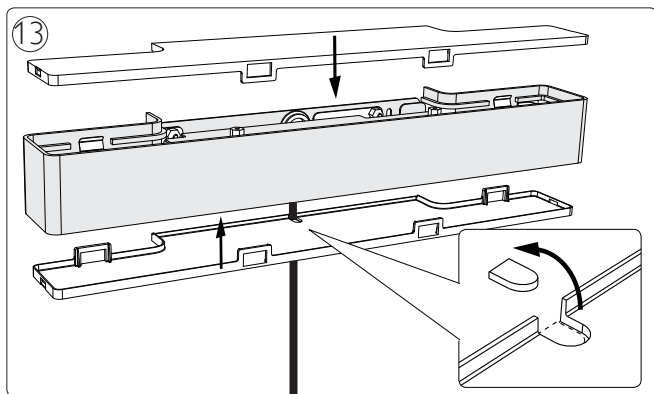



Philips Lighting Contact Centre  
Int. Business Reply Service  
I.B.R.S. / C.C.R.I. Numéro 10461  
5600 VB Eindhoven  
Pays-Bas / The Netherlands

[www.philips.com/homelighting](http://www.philips.com/homelighting)  
☎ +800 7445 4775

4404.018.17921  
Last update: 02/12/13