



40726/**/16

Gebruiksaanwijzing

Notice d'emploi

Benutzerhandbuch

User manual

Manual de usuario

Manual do usuário

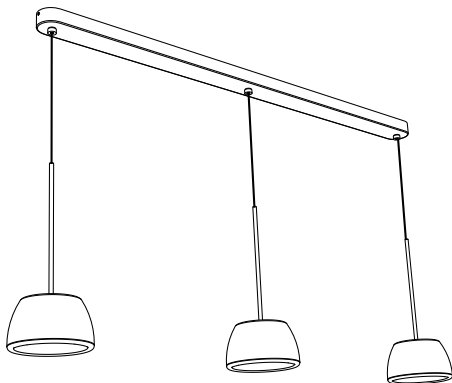

PHILIPS

Incl.



9 x Luxeon Rebel
Powered

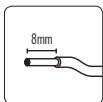
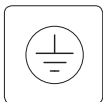
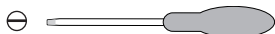
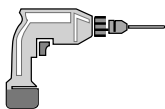
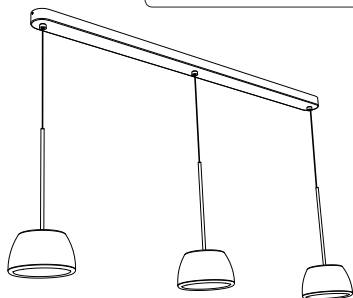

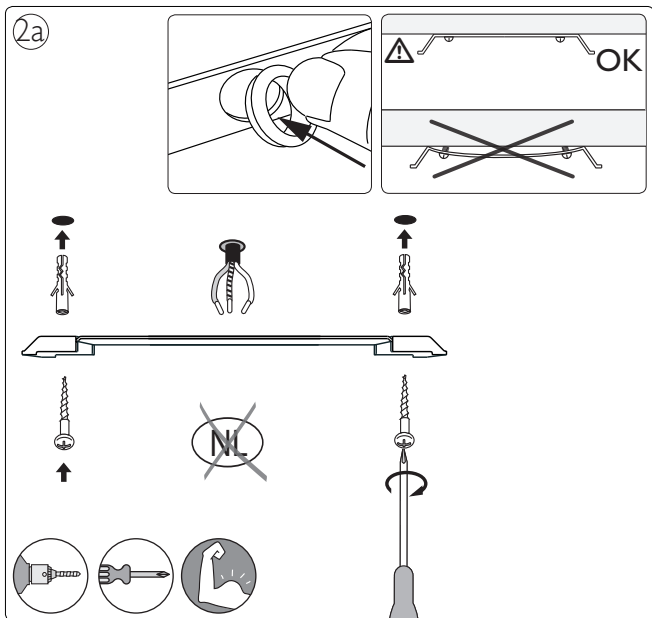
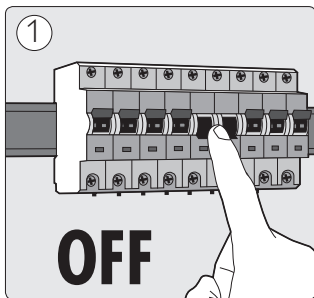

2b

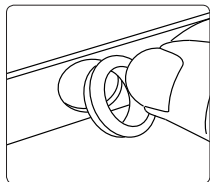
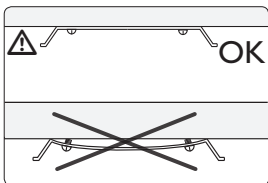
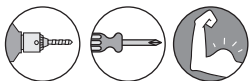
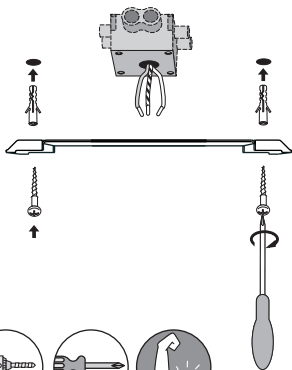

2c

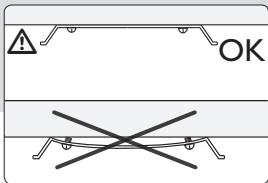
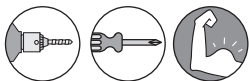
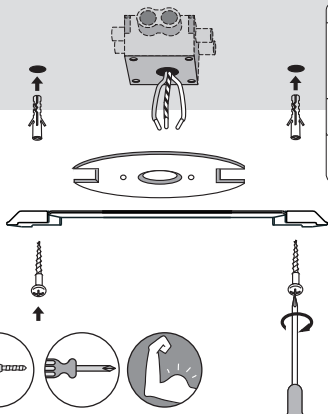

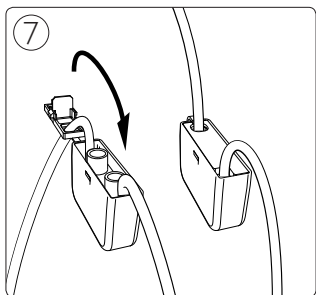
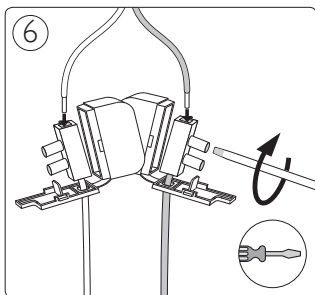
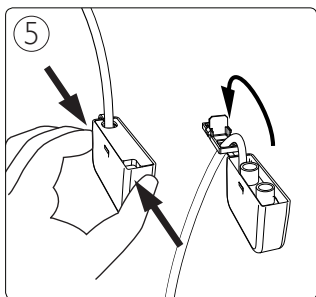
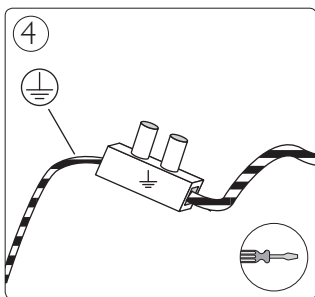
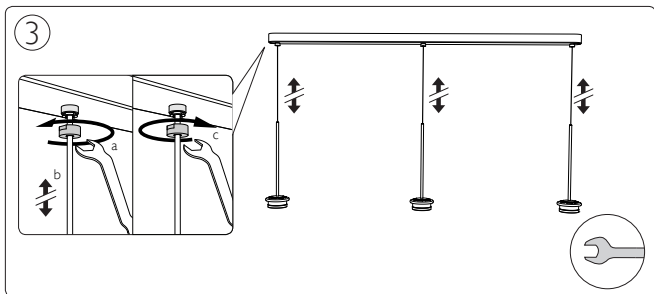

8

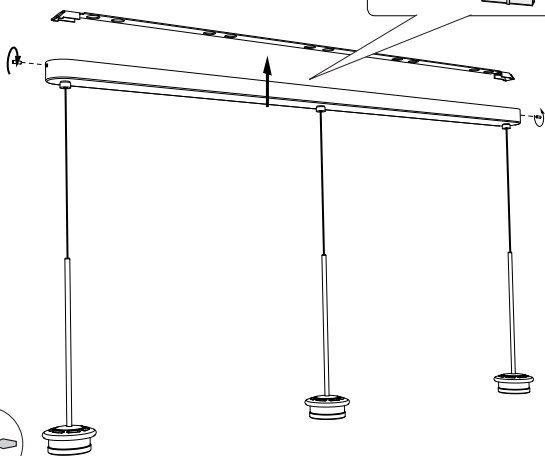
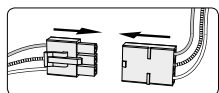
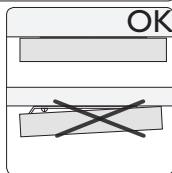
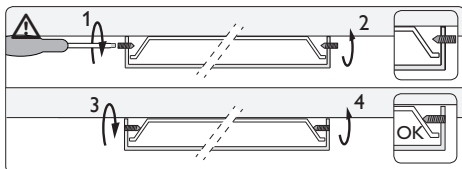

9

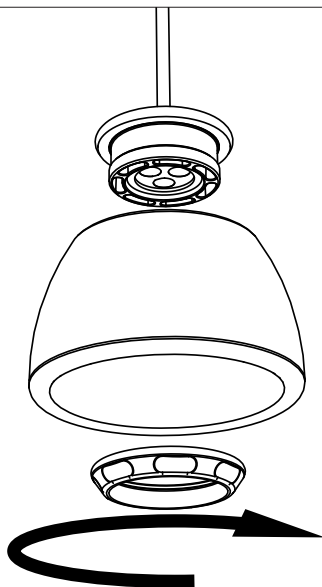



Philips Lighting Contact Centre
Int. Business Reply Service
I.B.R.S. / C.C.R.I. Numéro 10461
5600 VB Eindhoven
Pays-Bas / The Netherlands

www.philips.com/homelighting
☎ +800 7445 4775

4404.018.27271
Last update: 17/01/13