

33514/**/16

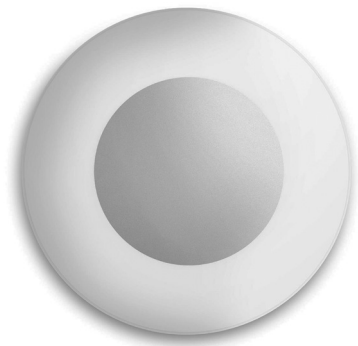

Gebruiksaanwijzing
Notice d'emploi
Benutzerhandbuch
User manual
Manual de usuario



PHILIPS

Incl.

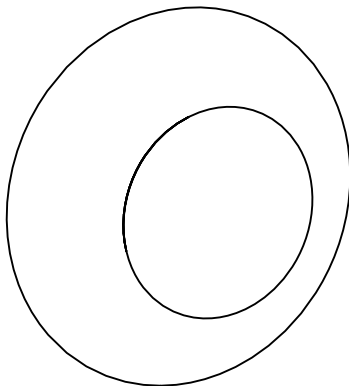
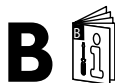

Excl.

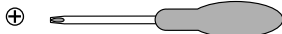
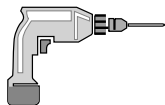

Type 1 → P4

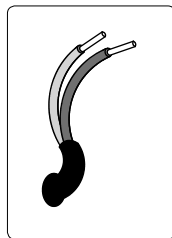
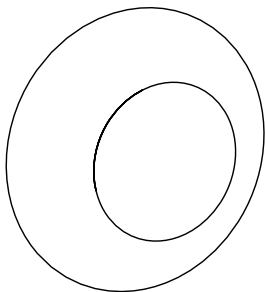

Type 2 → P8

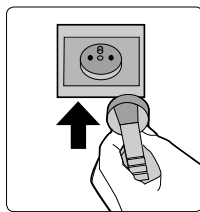
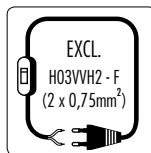
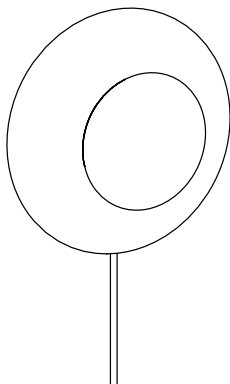

Type 1

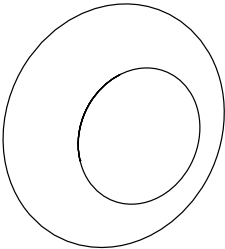

①

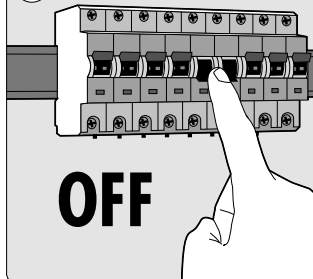

②

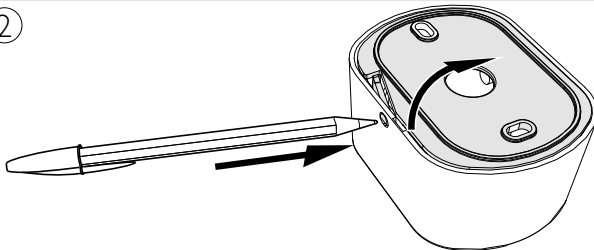

③a

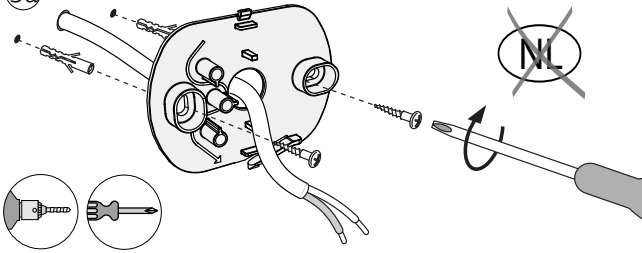

3b

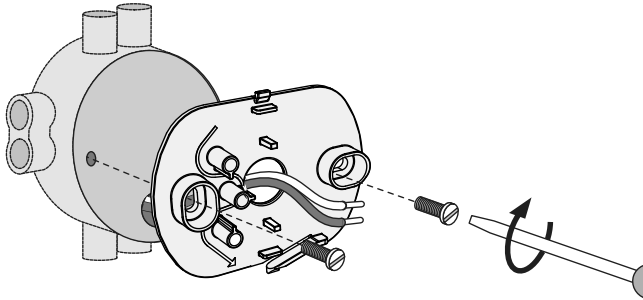

4

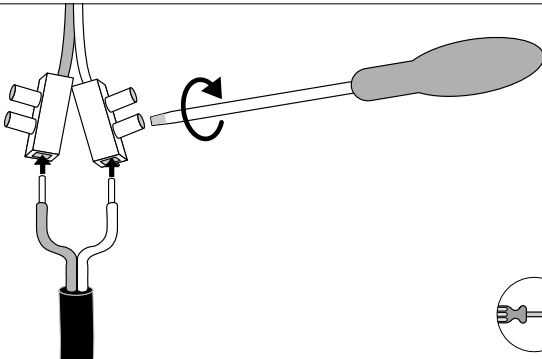

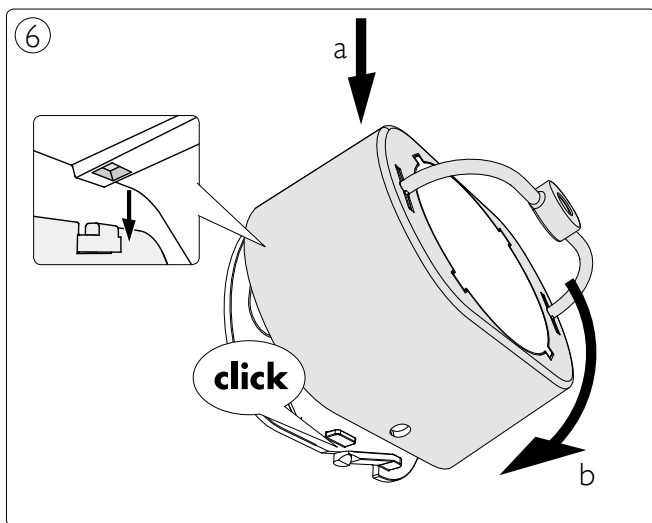
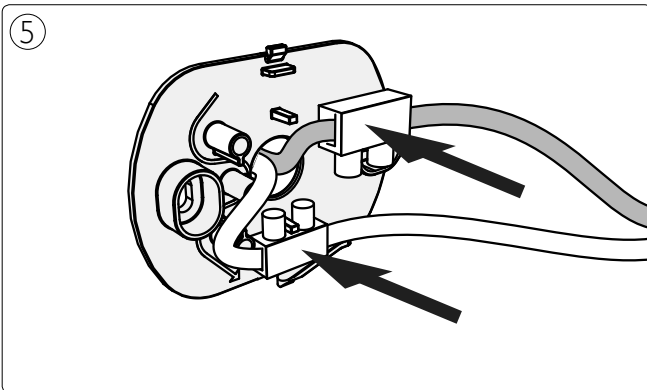

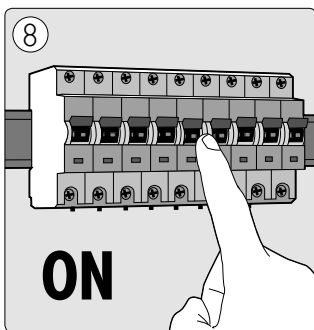
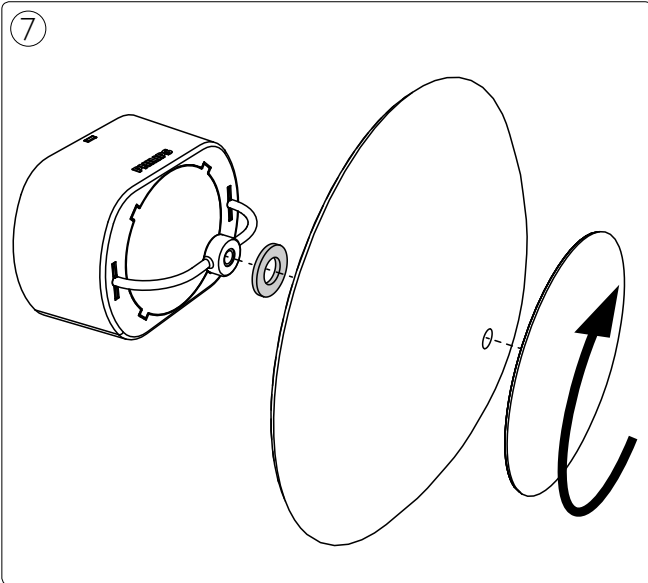

Type 2

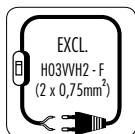
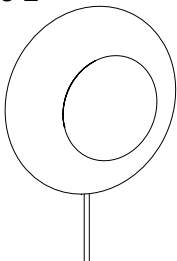

①

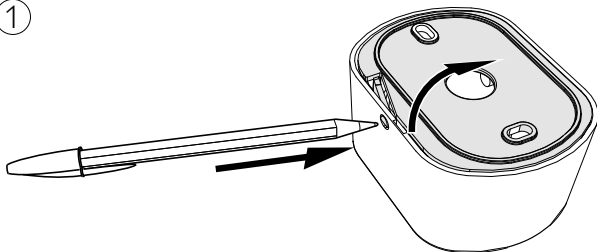

②

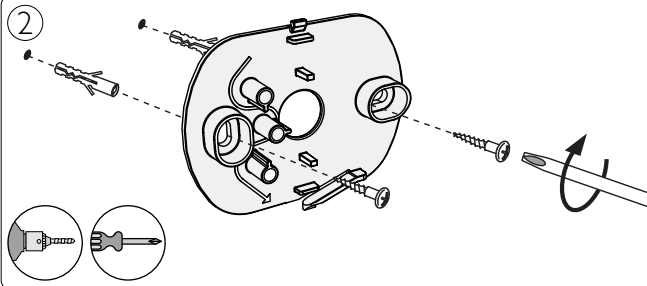

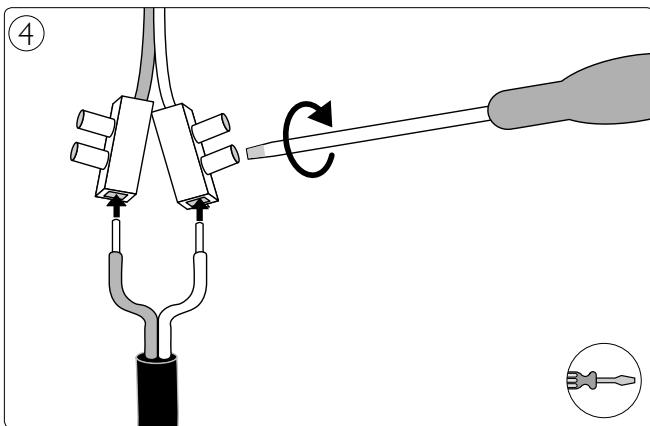
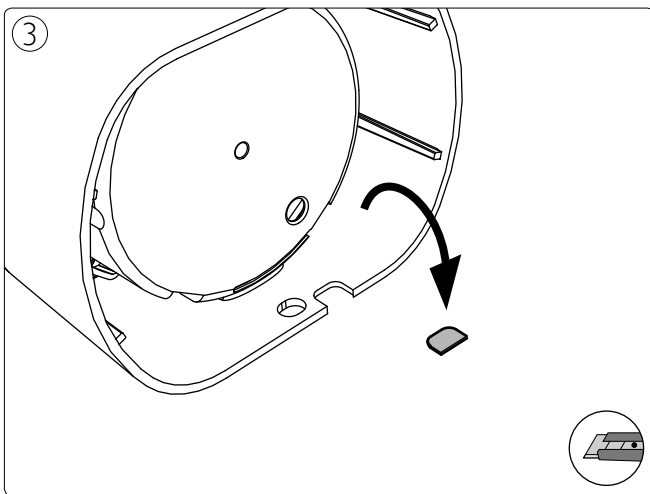

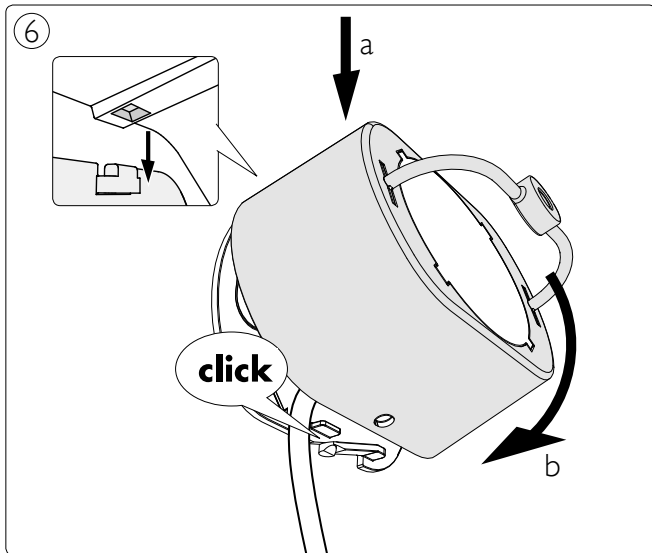
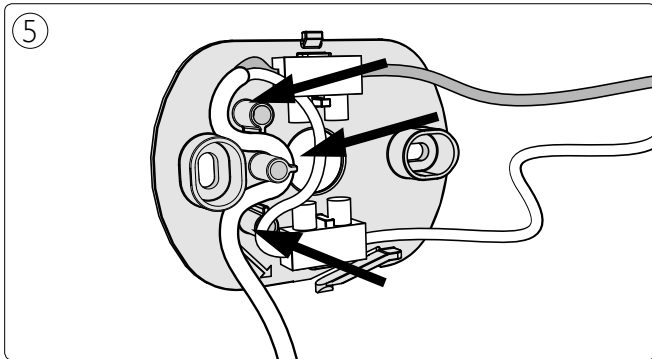

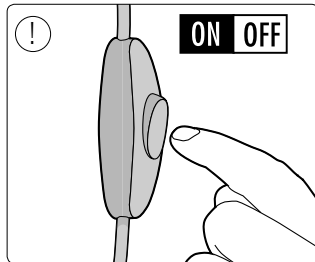
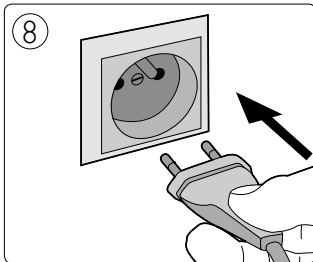
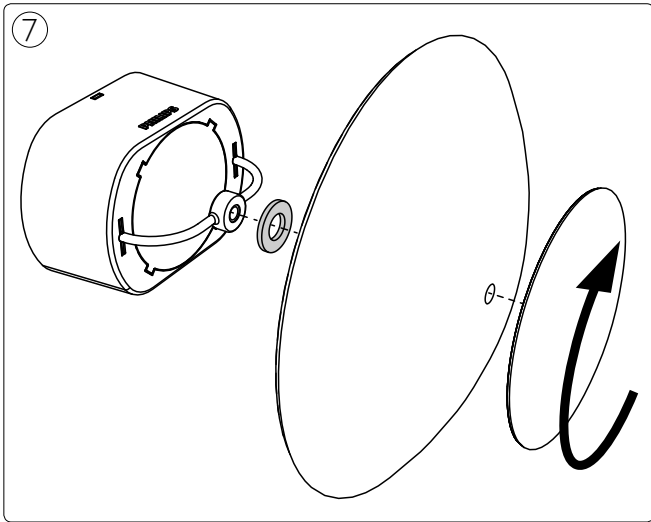



Philips Lighting Contact Centre
Int. Business Reply Service
I.B.R.S. / C.C.R.I. Numéro 10461
5600 VB Eindhoven
Pays-Bas / The Netherlands

www.philips.com/homelighting
☎ +800 7445 4775

4404.017.01151
Last update: 29/04/15