

53332/**/16



Gebruiksaanwijzing
Notice d'emploi
Benutzerhandbuch
User manual
Manual de usuario



PHILIPS

Incl.

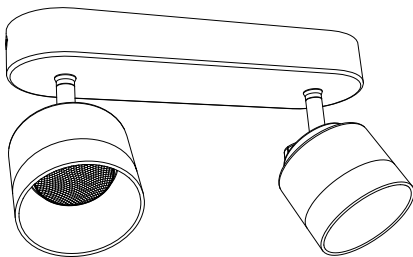
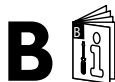

Excl.

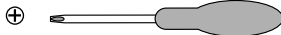
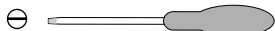
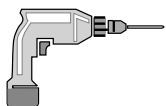

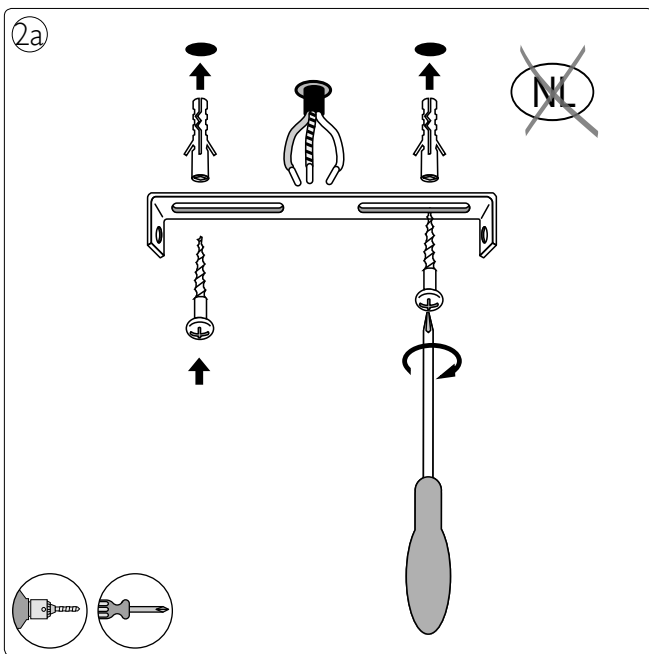
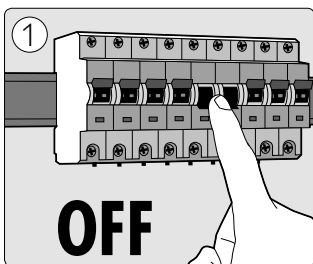

2b

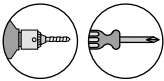
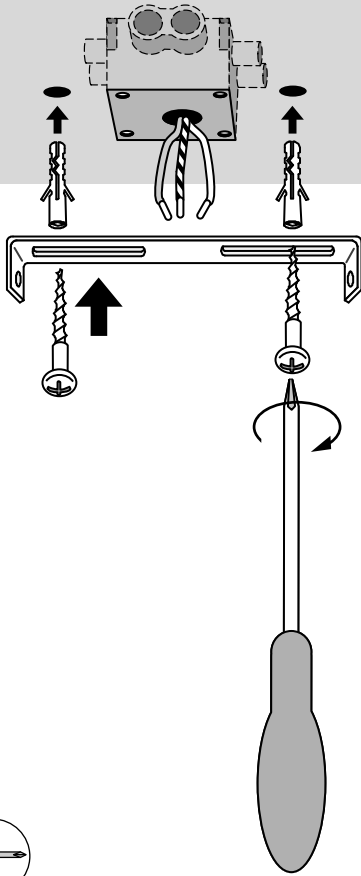

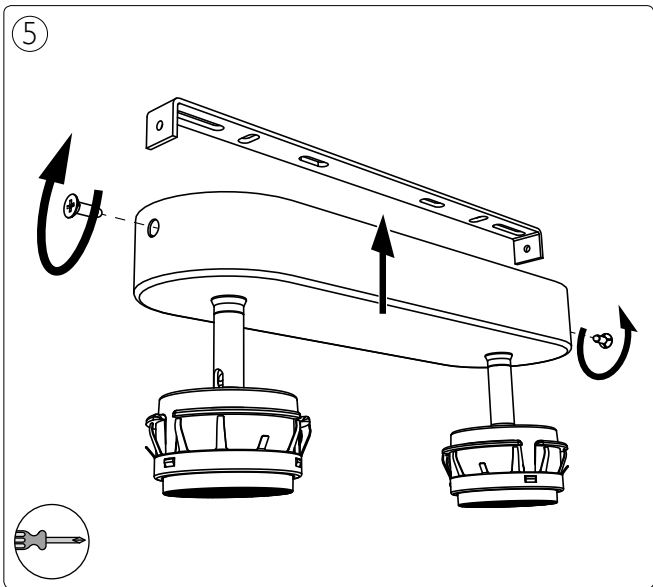
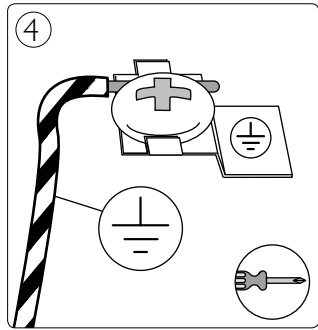
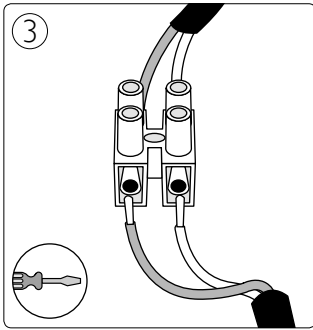

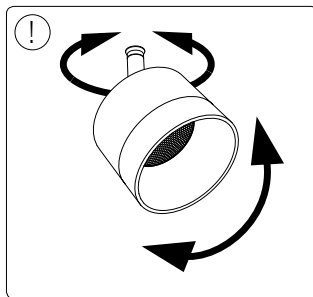
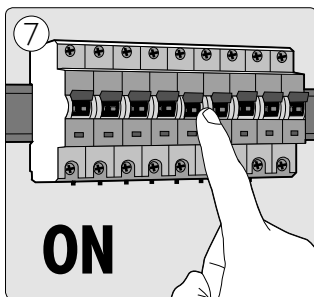
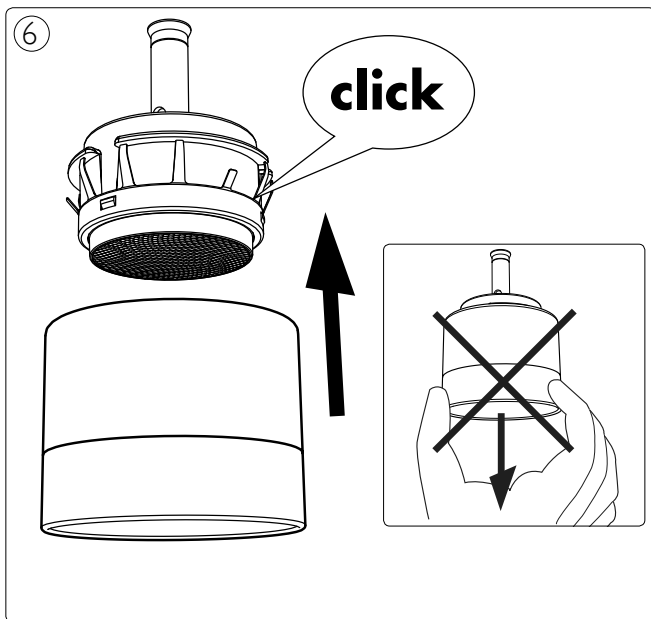



Philips Lighting Contact Centre
Int. Business Reply Service
I.B.R.S. / C.C.R.I. Numéro 10461
5600 VB Eindhoven
Pays-Bas / The Netherlands

www.philips.com/homelighting
☎ +800 7445 4775

4404.016.99831
Last update: 22/05/15